



OPERATING REQUIREMENTS:

- 120 V, 60 Hz
- Shop air 20 - 80 psi (clean & dry)

CAUTION: HOT AIR WILL BURN!!!
Place tool in Pod when not in use

971HA
ATMOSCOPE®
SMD Hot Air Station

- Automatic air shut-off
- Easy to use flow regulator
- Modulator assembly
- Easily converted to contact soldering with NO-FUME system
- ESD safe
- Hot air calibration capability
- Check valve equipped high pressure hose

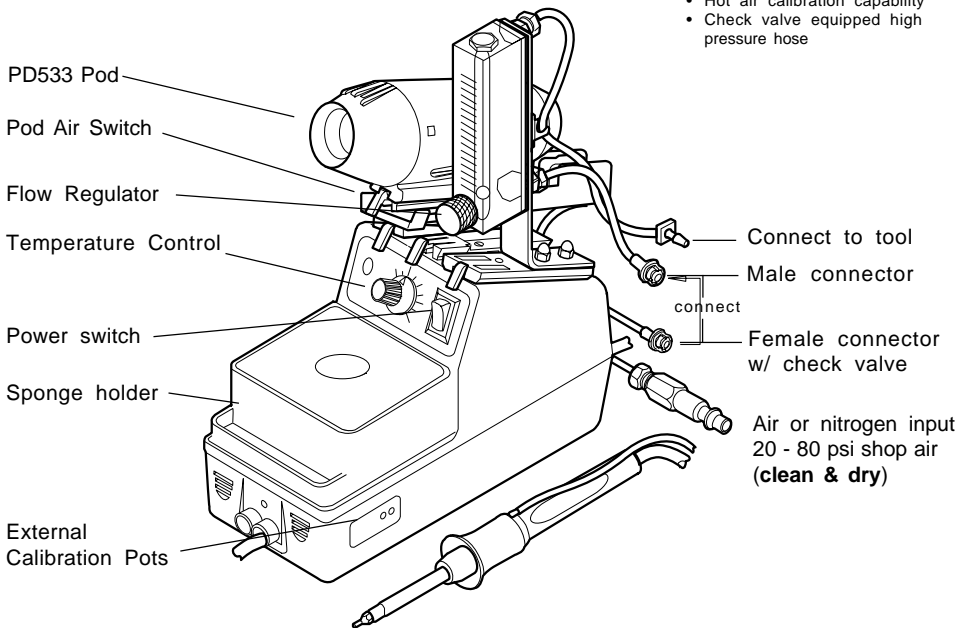

PR570 Flow Regulator

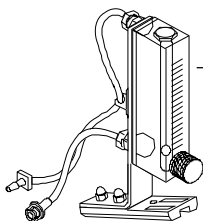

Measures flow in cubic ft per hour

Adjust flow by turning knob. Fully clockwise will shut off the flow.

PAS53 Pod Air Switch

(Tool Pod not shown)

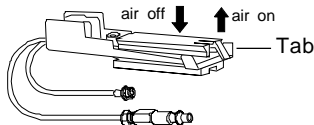

With tool out of the pod, push in Tab to lock: Air on (continuous)

With tool in the pod, push in Tab to lock: Air off (disable)

CHANGING TIPS

1. Turn Tip counter-clockwise by using a **WT620** Tip Wrench.
2. Remove and replace with desired Tip.

use a 5/16 wrench to hold the sleeve if tip is too tight.

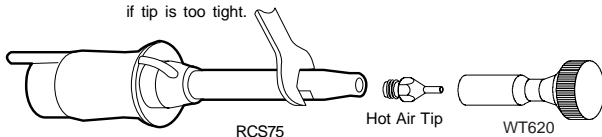

REWORKING SMDs

IMPORTANT

The 3 very important factors involved when working with the ATMOSCOPE SMD Hot Air Tool are *amount of air output, temperature setting and type of Tip used*. The key to an effective soldering is to reflow the solder **without blowing the solder** across the board and thus creating bridges.

The following techniques are based on the manufacturer's point of view and should only serve as guidelines. Its effectiveness will depend on practice.

DON'T!

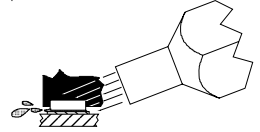

FOR RESISTORS, CAPACITORS, TRANSISTORS AND ALIKE.

1. Have the proper Tip installed.
2. Adjust air output to about 2-4 scfh.
3. Set temperature between 700°F to 800°F.
4. Heat up the joints until the solder melts.
5. Remove by using a pair of tweezers.
6. To resolder, hold SMD in place making sure leads are aligned with solder pads.
7. Direct hot air flow to the connection until solder reflows. Release SMD when solder solidifies.

tweezers

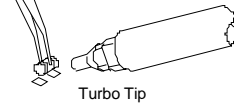

Turbo Tip

Dual Flow Tip

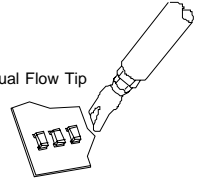

FOR GULLWINGS, LEADLESS CHIP CARRIERS and QUAD I.C.s METHOD 1

1. Install the proper Tip.
2. Adjust air output to 2-4 scfh.
3. Set temperature to 700°F.
4. Using a **WS630** SMD Pull Wire, thread the pullwire under the leads of one side of the SMD and again thread the wire under the leads of the opposite side.
5. Anchor one end of the Pull Wire to an unused hole of the circuit board or maybe tape it securely to the board.
6. While directing hot air to the leads of the first side, pull the wire so that it will cut thru the solder connection.
7. After removing the two opposing side follow the same procedure to desolder the remaining sides.
8. To resolder, use a tweezer to hold SMD in place and align the leads with the pads.
9. Use a Fan Tip whose width is as close to the size of the SMD leads as possible.
10. Direct hot air on the leads and allow solder to reflow. Release SMD when solder solidifies.

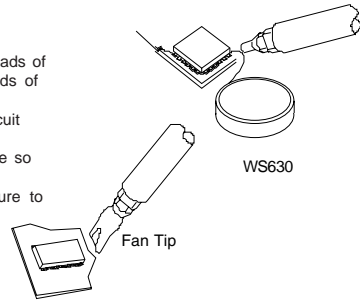

WS630

Fan Tip

METHOD 2

1. Have the proper Tip installed.
2. Adjust air output to about 2-4 scfh.
3. Set temperature to 700°F.
4. Heat up one corner of the SMD.
5. When the solder melts, insert the shimblade of SMD helper under the heated area of the chip as if cutting thru the solder connection.
6. While directing hot air ahead of the shim at all times, cut thru the sides of the SMD and lift it up from the board.
7. To resolder, use a Quadra-Flow Tip.

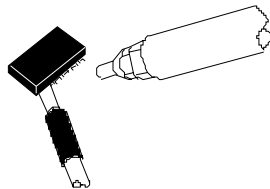

USING QUADRA-FLOW TIPS (RECOMMENDED FOR FOUR SIDE LEADED COMPONENTS)

Quadra flow Tips come in a variety of sizes. Increase air output as you increase the size of the Tip.

1. Place Quadra-Flow Tips over the SMD.
2. After waiting for the solder to melt, twist tool gently to see if the SMD is freed.
3. Remove SMD by using a pair of tweezers.
4. To resolder, glue SMD to the board with the leads aligned with the pads.
5. Place Quadra-Flow Tip over SMD and allow solder to reflow.

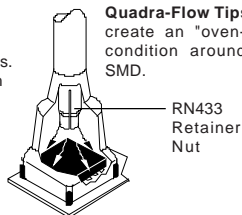

Quadra-Flow Tips

create an "oven-like" condition around the SMD.

RN433 Retainer Nut

Use WT620 Tip Wrench to install Tips with RN432 or RN433

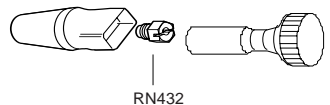

RN432

SMD Hot Air Tips

See Catalog for SMD Helpers, Pull Wires and other tools used in aiding SMD removal and placing.

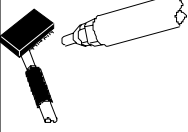
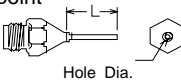
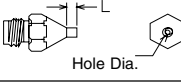
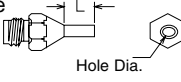
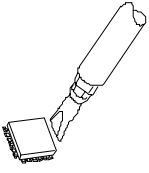
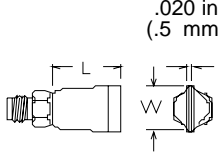
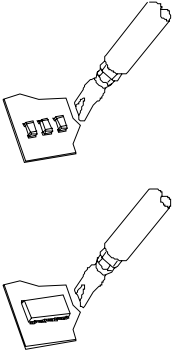
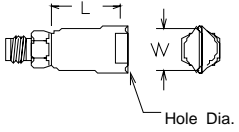
Application	Description	Part No.	Hole Dia.	L	W
	Jet Tip for pin point air flow. 	LT427	.02 in. 1/64 in. (0.6 mm)	.38 in. 3/8 in. (9.5 mm)	—
	Short Jet Tip for medium air 	LT432	.04 in. 3/64 in. (0.9 mm)	.06 in. 1/16 in. (1.5 mm)	—
	Turbo Flow for large air flow. 	LT428	.06 in. 1/16 in. (1.5 mm)	.25 in. 1/4 in. (6.4 mm)	—
	Fan Tips use a wide air flow enough to cover one whole side of the SMD. 	LT426	—	.30 in. 5/16 in. (7.6mm)	.17 in. 3/16 in. (4.3 mm)
	LT434	—	.46 in. 15/32 in. (11.7 mm)	.23 in. 15/64 in. (5.7 mm)	
	LT435	—	.59 in. 19/32 in. (14.9 mm)	.35 in. 3/8 in. (8.9 mm)	
	LT436	—	.65 in. 21/32 in. (16.5 mm)	.43 in. 7/16 in. (10.8 mm)	
	Dual Flow Tips blow hot air on both sides of the SMD, not on the SMD. 	LT526	.03 in. 1/32 in. (0.8 mm)	.30 in. 5/16 in. (7.6 mm)	.12 in. 1/8 in. (3.2 mm)
	LT534	.05 in. 3/64 in. (1.2 mm)	.46 in. 15/32 in. (11.7 mm)	.20 in. 13/64 in. (5.1 mm)	
	LT535		.59 in. 19/32 in. (14.9 mm)	.28 in. 17/64 in. (7.0 mm)	
	LT536	.65 in. 21/32 in. (16.5 mm)	.35 in. 23/64 in. (8.9 mm)		

**Apply AN112 or AN122
ANTI-SEIZE COMPOUND**

To Heater and Area of Tip Contact.
AN122 comes in syringe dispenser.

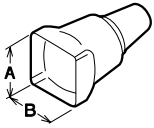

SMD Hot Air Quadra-Flow Tips
ALWAYS USE PD529 or PD529A TOOL PODS

Fractional dimensions are approx.

PART NO.	A x B		FITSPACKAGE (for reference only)
	(in.)	(mm)	
LT448*	.21 x .35 7/32 x 11/32	5.3 x 8.9	SO-14
LT483*	.25 x .43 1/4 x 7/16	6.4 x 10.9	Ceramic DIP 16
LT489	.25 x .78 1/4 x 25/32	6.4 x 19.8	
LT449	.26 x .41 1/4 x 13/32	6.6 x 10.4	SO-16
LT480	.31 x .52 5/16 x 33/64	7.9 x 13.2	LCCC-22R
LT478	.32 x .45 5/16 x 29/64	8.0 x 11.4	LCCC-18R
LT462	.34 x .55 11/32 x 35/64	8.7 x 13.9	PLCC-18
LT470*	.36 x .36 23/64 x 23/64	9.2 x 9.2	LCCC-20
LT487	.36 x .60 23/64 x 39/64	9.1 x 15.2	
LT452	.38 x .52 3/8 x 33/64	9.5 x 13.2	SO-20L
LT481	.38 x .58 3/8 x 37/64	9.5 x 14.6	LCCC-28R
LT455	.40 x .40 13/32 x 13/32	10.2 x 10.2	PLCC-20
LT486	.40 x .60 13/32 x 13/64	10.2 x 15.3	
LT484	.40 x .79 13/32 x 51/64	10.2 x 10.2	SOJ-20
LT450	.42 X .43 7/16 X 7/16	10.7 X 10.9	SO-16L
LT454	.43 x .73 7/16 x 18.6	10.9 x 18.6	SO-28L
LT451	.44 X .48 7/16 X 31/64	11.2 X 12.2	SO-18L
LT493	.45 x .85 29/64 x 55/64	11.3 x 21.6	SOJ-32
LT494	.45 x 1.05 29/64 x 13/64	11.4 x 26.7	SOJ-40
LT482	.47 x .58 15/32 x 37/64	11.9 x 14.6	LCCC-32R

*RN432 not required in Application set up

**Comes w/ RN433

Fractional dimensions are approx.

PART NO.	A x B		FITSPACKAGE (for reference only)
	(in.)	(mm)	
LT472S	.48 x .48 31/64 x 31/64	12.2 x 12.2	
LT472	.49 x .49 1/2 x 1/2	12.4 x 12.4	LCCC-28
LT456	.50 x .50 1/2 x 1/2	12.7 x 12.7	PLCC-28
LT485	.52 x .64 33/64 x 44/64	13.2 x 16.2	
LT463	.60 x .60 39/64 x 39/64	15.2 x 15.2	
LT468**	.66 x .90 21/32 x 29/32	16.8 x 22.9	QFP-100
LT458**	.70 x .70 45/64 x 45/64	17.8 x 17.8	PLCC44 LCCC-44
LT491**	.71 x .94 23/32 x 15/16	18.0 x 23.9	
LT477**	.75 x 1.00 1/4 x 1	19.0 x 25.4	LCCC-84
LT459**	.80 x .80 51/64 x 51/6	20.3 x 20.3	PLCC-52
LT492**	.85 x .85 55/64 x 55/64	21.6 x 21.6	
LT460**	1.0 x 1.0 1 x 1	25.4 x 25.4	PLCC-68
LT488**	1.17 x 1.17 111/64 x 111/64	29.7 x 29.7	QFP-144

*RN432 not required in Application set up

**Comes w/ RN433

Bendable Hot Air Tips

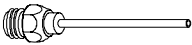
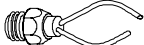
 <p>1.1" nozzle</p> <p>LT571LONER® Long-Flow Bendable</p>	 <p>LT572LONER® Dual-Flow Adjustable</p>
--	--

Using a special Bending Tool, WT622, the Dual-Flow and Long-Flow Nozzle that can be bent to accommodate most SMD sizes.

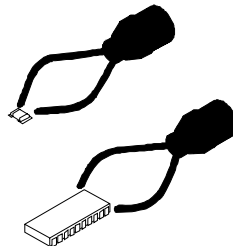
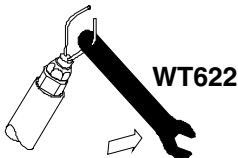

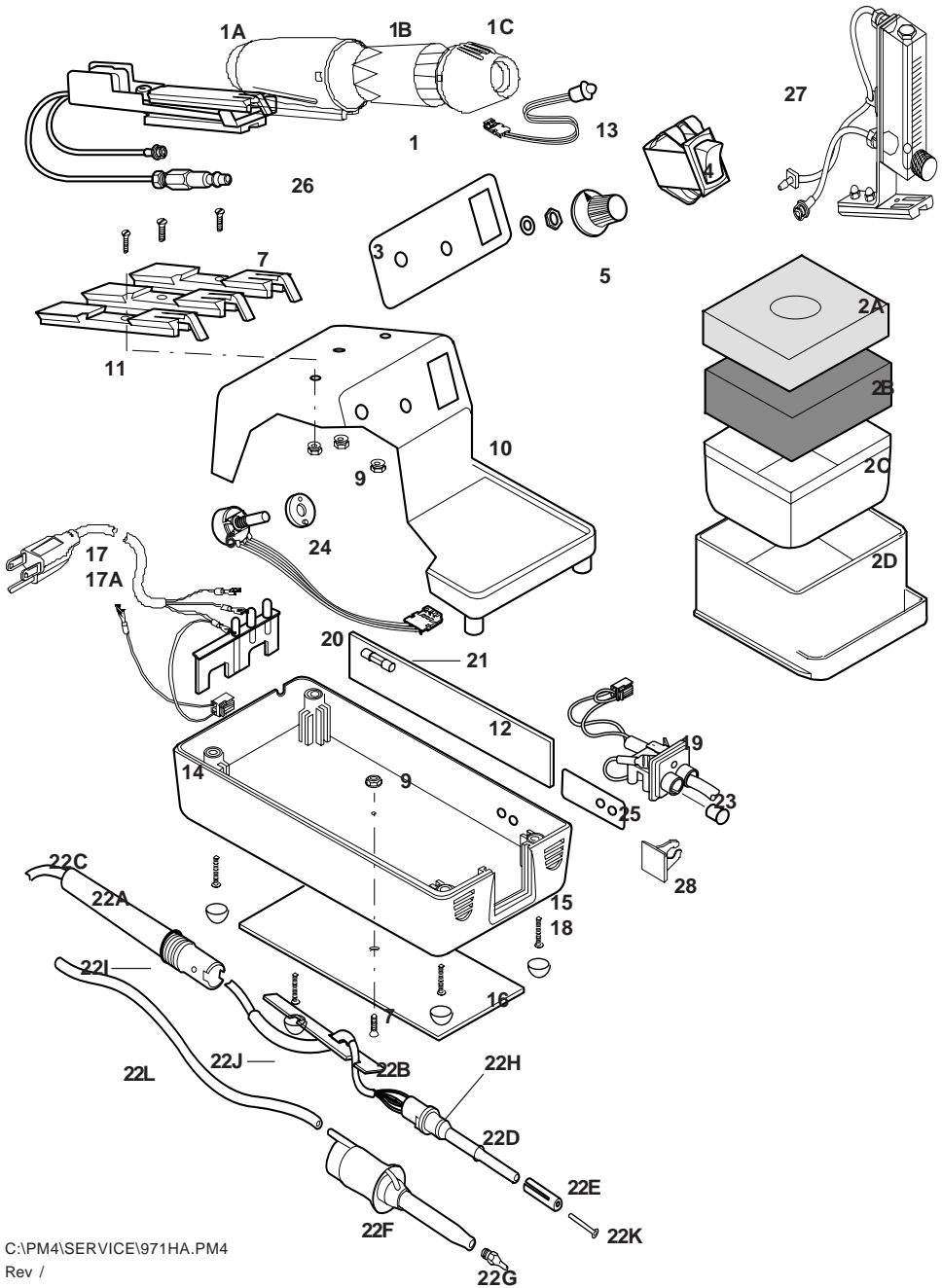

C:\PM4\SERVICE\971HA.PM4
Rev /

ITEM NO.	PART NO.	DESCRIPTION	QTY REQD
1	PD533	Tool Pod for Hot Air Tool	1
1A	SR042	Thermal Housing for Tool Pod	1
1B	SC581	Solder Collector for Tool Pod	1
1C	SR457	Front Housing for Tool Pod	1

971HA LONER® ATMOSCOPE®
SMD Hot Air SOLDERING STATION
SPAREPARTSLIST

ITEM NO.	PART NO.	DESCRIPTION	QTY REQD
2	SH230	General Purpose Sponge Holder	1
2A	RS199	Cleaning Sponge	1
2B	RS243	Leveling Pad for SH230	1
2C	LN230	Liner for SH230	1
2D	SH230-1	Sponge Holder Tray	1
3	SR577	Control Panel Label	1
4	SR065	Power Switch, Illuminated	1
5	SR045	Knob, Temperature Control	1
6	SR243	5K Potentiometer, Temperature Control	1
7	SR015	Flat Head Screw- Slotted #6 - 32 x 1/2	4
9	SR467	Hex Nut, Square Cone- #6 - 32	4
10	SR741	Top Base	1
11	SR019	Dove Tail Mount	1
12	15002W95	Circuit Board	1
13	SR573	LED Assy. Front Panel Mount	1
14	SR247	Bottom Base	1
15	SR011	Pan Head Screw- Phillip #6 - 18 x 5/8	4
16	SR054	Bottom Weight	1
17	SR252	Power Cord Assy.	1
17A	SR026	Power Cord only (Connectors not included)	1
18	SR251	Rubber Foot	4
19	SR226	Strain Relief Block for Tool Cord (Tool & Cord Assy. not included)	1
20	SR241	Strain Relief for Power Cord	1
21	SR249	Fuse, 250V, 1.6 A (5mm x 20 mm)	1
22	SR620	Hot Air Soldering Tool, Complete Assembly	1
22A	SR579	Handle for Tool	1
22B	SR058	Tool Cord Strain Relief	1
22C	SR280	Tool Cord, Burn Proof (Connector Assy. on one end)	1
22D	SR574	Heater Assembly	1
22E	LTC71	Tip Collet	1
22F	RCS75	Retaining Collar and Sleeve for Hot Air	1
22G	LT428	SMD Hot Air Turbo Tip	1
22H	SR001	O-Ring, Silicone, .30 ID	1
22I	SR240	O-Ring, For Handle	1
22J	SR525	Hose, Low Static, 1/4 I.D.. (sold per ft)	5 1/4"
22K	LTA75H	Accumulator for Hot Air	1
22L	HS307	Hose, Low Static Silicone, 1/8 I.D. (sold per ft.)	3 ft.
23	SR301	Plug, Covering for Strain Relief, Tool Cord Outlet	1
24	SR255	Spacer for Potentiometer	1
25	SR310	Label, Set Pot, Right Front or Left Rear	1
26	PAS53	Air Cut-Off Switch	1
27	PR570	Air Flow Regulator	1
28	SR439	Clip, Holder for Hose and Filter	1

HOT AIR CALIBRATION

It is highly recommended to use new or a very clean thermo-couple wires (never been use to calibrate soldering tips)

FOLLOW SET-UP AS ILLUSTRATED

1. With the Hot Air Tip inside the **TPL09-1**, place the center of the thermo-couple wire of the **SDS100** inside the slot of **TPL09-1** Locator.
2. Turn on power and set Temperature Control Knob to 400°F.
3. Turn Regulator Knob to 4 - 5 SCFH.
4. Adjust LO-Temp. Calibration Pot so the Meter will read 400°F.
5. Set Temperature Control Knob to 800°F.
6. Adjust Hi-Temp. Calibration Pot so the Meter will read 800°F.

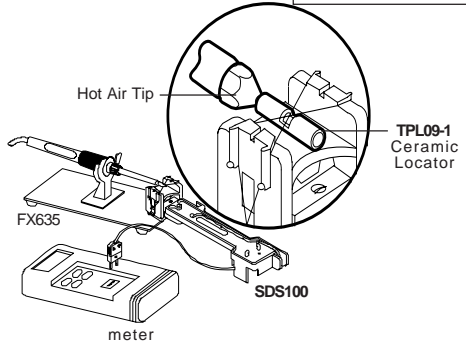

OPTIONS

The 971HA can be converted to a contact soldering with No Fume system. Ask for the VS174 and RCS73. Remember to remove the LTA75H from the heater accumulator. (see spare parts list)

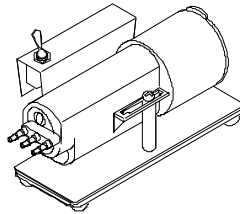

VS174 Vacuum pump and filter, shop air operated.

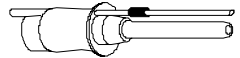

RCS73 Collar with fume extraction pipe

SPECIFICATIONS

- 120V, 70 W
- 0 to 20 SCFH flow meter
- Temperature range: 400°F - 800°F (205°C - 425°C)
- Temperature regulation: $\pm 6^\circ\text{F}$ ($\pm 3^\circ\text{C}$)
- Voltage leakage from tip to ground less than 2 MV
- Tip to ground resistance less than 2 ohm
- Complies with MIL-S-45743E, DOD-STD-2000-1B, MIL-STD-2000 WS6536E and ESD SPEC, DOD-STD-1686, DOD-HDBK-263.
- UL listed



Intellectual
Property



15958 ARMINTA ST. VAN NUYS, CA 91406-1896
PHONE: 818.989.2324 FAX (sales): 818.997.0895
Email: info@edsyn.com Internet: www.edsyn.com